

Circulate to: Sales Manager Accounting Service Manager Technician Parts Manager

Diagnostic Supplement for MerCruiser Engines with Emission Control Technology (ECT)

NOTICE
Revised January 2014. This bulletin supersedes the previous bulletin number 2011-11R1 November 2011.

Scope

Worldwide.

Models Affected

Models Covered
All sterndrive and inboard engines with emissions control technology (ECT)

Situation

After a customer has been notified by the warning horn, OBD-M malfunction indicator lamp (MIL), or a SmartCraft gauge message, the CDS G3 service tool reports "OBDM Fault: Engine Misfire Limit Exceeded" in "Active Faults" and fault 396 in "Freeze Frame Data" buffers. In subsequent testing, however, the technician is often unable to detect the cause of a cylinder misfire.

396	Engine Misfire	396 - OBDM Fault: Engine Misfire Limit Exceeded
-----	----------------	---

Cause

The fault indicates that the PCM detected excessive cylinder misfire. The PCM can detect cylinder misfire before a technician can detect it. Since the misfiring is not detectable by the technician in most cases, correcting this fault can be very difficult for those unfamiliar with diagnosing emissions-related systems.

NOTE: The "Cylinder Misfire Detection" program runs continuously, regardless of RPM, load, and fuel control mode.

Diagnostic Information

This bulletin provides information on the probable causes of the "Cylinder Misfire Limit Exceeded" fault and outlines a diagnostic procedure to efficiently resolve the fault. Cylinder misfire in 4-stroke gasoline engines can be caused by many different engine systems and components. Cylinder misfire is not something new and unique to MerCruiser ECT engines. What is new is the PCM's ability to detect cylinder misfire and set a diagnostic fault.

The actual cause of cylinder misfire can be as varied as the systems and components that make up a complete engine. A technician must remember the basics of engine operation—intake, compression, ignition, and exhaust—when determining the root cause of a misfire fault. Never assume that the PCM 09 is the cause of the misfire unless complete and thorough diagnostics prove it defective. Likely causes of misfire can be found in two major areas—engine components and systems. Within these areas, the causes include:

- Mechanical problems related to valve operation
 - Sticking intake or exhaust valves
 - Crankcase oil level too high, causing oil aeration and hydraulic lifter malfunction

THE INFORMATION IN THIS DOCUMENT IS CONFIDENTIAL AND PROTECTED BY COPYRIGHT AND IS THE PROPERTY OF MERCURY MARINE.

This document is provided for the sole and exclusive use of the original recipient as prescribed by Mercury Marine and may not be distributed or copied, digitally or otherwise, without the prior written consent of Mercury Marine.

- Combustion chamber leakage caused by damaged cylinders, pistons, rings, head gaskets, and valves
- Dirty or damaged fuel injectors, fuel filters, or fuel lines
- Fuel rail pressure not within specifications
- Gasoline that does not meet the minimum specifications listed in the MerCruiser Operation, Maintenance, and Warranty manual
- Degraded, contaminated or otherwise unusable gasoline
- Electrical system problems
 - Damaged, melted, or corroded harnesses and cables
 - Damaged connectors, terminals, and internal splices
- Ignition system problems
 - Weak or erratic spark
 - Incorrect or erratic ignition timing
 - Damaged or defective spark plug wires
 - Damaged, defective, or incorrect spark plugs
 - Nonresistor spark plugs or spark plug leads installed
 - Corrosion in the distributor cap
- Product installation, rigging issues, or both
 - Incorrect drive gear ratio
 - Incorrect X-dimension
 - Incorrect application (power-to-weight ratio)
 - Incorrect propeller selection
- Vibrations or frequencies in the drivetrain
 - Propeller ventilation and cavitation
 - Propeller damage and defective repairs
 - Sterndrive gear failure
 - Bent or twisted propeller shafts
- Incorrect operation of the engine (Refer to the MerCruiser Operation, Maintenance, and Warranty manual provided with the product.)
- Incorrect use of the tilt and trim system (Refer to the MerCruiser Operation, Maintenance, and Warranty manual provided with the product.)
- Electromagnetic interference (EMI) or radio frequency interference (RFI)
 - CAN circuit leads routed close to the spark plugs or spark plug wires
 - Nonresistor spark plugs or spark plug leads installed

Special Cases

The service bulletin also addresses two special misfire cases:

1. Some engines, dating back to 2002, were manufactured with the yellow-flag type circuit breaker, which has been associated with misfires between 2000 and 4000 RPM, the engine is at its peak load, as when working to get the boat up on plane. Refer to **Misfires Due to Yellow-Flag-Type 50-Amp Circuit Breaker** later in the document for information on diagnosing and repairing this issue.
2. 5.0L, 5.7L, and 6.2L EC engines with low hours, no other faults, and misfiring occurring when the engine is put under high load, such as when coming on plane. Refer to **5.0L, 5.7L, and 6.2L ECT Engines Misfire with Low Engine Hours and No Other Active Faults** later in this document for more information on diagnosing and addressing this issue.

Related Service Bulletins

- **MerCruiser Service Bulletin 2011-06:** Replacement Distributor Cap on MerCruiser MPI Engines With HVS Ignition Systems (5.0, 5.7 and 6.2 models)
- **MerCruiser Service Bulletin 2011-08:** Crankshaft Position Sensor Connection

THE INFORMATION IN THIS DOCUMENT IS CONFIDENTIAL AND PROTECTED BY COPYRIGHT AND IS THE PROPERTY OF MERCURY MARINE.

This document is provided for the sole and exclusive use of the original recipient as prescribed by Mercury Marine and may not be distributed or copied, digitally or otherwise, without the prior written consent of Mercury Marine.

Misfire Tests

A **misfire** may be defined as an **unexpected change of speed in subsequent power strokes of the engine**. A misfire can let raw fuel into the catalyst and can quickly cause expensive damage. This is one reason why you cannot simply remove a spark plug wire while the engine is running. Always use CDS G3 to check the catalysts for damage after diagnosing a misfire fault.

Misfire is a special OBD-M II fault that records the load and speed at which the misfire occurs. The CDS G3 misfire data table has 81 possible load and speed bins that can be set to **Pending**. The fault is set only after a second run cycle at the same load and speed. This is why clearing a misfire fault is difficult without the CDS G3 tool.

CDS G3 Diagnostic Interface Tool With Harness	8M0046124
	Provides diagnostic support for the Computer Diagnostic System.

IMPORTANT: To ensure that a misfire issue has been resolved, clear the fault in CDS G3 and water test the boat for two run cycles at the same RPM and load at which the last misfire was recorded in CDS G3's freeze frame. It takes two run cycles for a misfire fault to be triggered.

After a misfire fault is cleared, it is important to perform a water test of the boat at the same RPM and load as recorded in the freeze frame buffer of CDS G3 when the fault occurred. This must be done for two run cycles to ensure that the misfire issue has been eliminated. The tests are complete when **FinishedKey** is shown in the status of the port and starboard catalyst monitors. Refer to **Water Testing** for more information. Simply clearing the fault from CDS G3 is insufficient to be certain that the issue has been resolved.

IMPORTANT: Always check the catalysts for damage after diagnosing a misfire fault.

Depending on the length and severity of the misfire issue, the catalysts may have been damaged. Use CDS G3 to ensure that they are still able to function as intended. Refer to **Water Test Procedure** or **Service Manual #49, PCM 09 Diagnostics** for more information.

IMPORTANT: Do not drop cylinders, pull spark plug wires, or disconnect injectors while trying to diagnose the power loss of a cylinder. There are other methods that can be used to diagnose dead cylinders. Catalysts can be damaged by allowing raw fuel to pass through the engine.

Misfire Troubleshooting

After a customer has been notified by the warning horn, OBD-M light, or a SmartCraft gauge message, the CDS G3 service tool reports "OBDM Fault: Engine Misfire Limit Exceeded" in "Active Faults" and fault 396 in "Freeze Frame Data" buffers.

NOTICE

Catalytic converters can be damaged by an excessively rich fuel mixture. Remove power from the fuel pump by disconnecting it from the engine harness before turning over an engine when any one of the spark plugs or ignition coils are disconnected.

396	Engine Misfire	396 - OBDM Fault: Engine Misfire Limit Exceeded
-----	-----------------------	---

The fault indicates that the PCM detected excessive cylinder misfire. It is usually preceded by the customer being alerted through a warning horn, OBD-M light, or a SmartCraft gauge message. Since the misfire is not detectable by the technician in most cases, correcting this fault can be difficult for those unfamiliar with diagnosing emissions-related systems.

NOTE: The cylinder misfire detection program runs continuously, regardless of RPM, load, and fuel control mode.

THE INFORMATION IN THIS DOCUMENT IS CONFIDENTIAL AND PROTECTED BY COPYRIGHT AND IS THE PROPERTY OF MERCURY MARINE.

This document is provided for the sole and exclusive use of the original recipient as prescribed by Mercury Marine and may not be distributed or copied, digitally or otherwise, without the prior written consent of Mercury Marine.

CDS G3 Misfire Data Items

Knock Retard	0.0,0.0,0.0,0.0,0.0,0.0,0.0,0.0								KnkSpkAdv
	Cyl1	Cyl2	Cyl3	Cyl4	Cyl5	Cyl6	Cyl7	Cyl8	
KnkSpkAdv	0.0	0.0	0.0	0.0	0.0	0.0	0.0	0.0	
Engine Misfire	12.50								Engine_PercentMisfire
Cylinder Misfire (in firing order)	0,0,0,0,2,9,0,0								CylMisfire_CountArr
	0	0	0	0	2	9	0	0	

49038

CDS G3's misfire portion of the "Live Data" screen

- a** - The overall percentage of time that the engine is experiencing a cylinder misfire on any cylinder
- b** - A fault will be set if this number exceeds the critical threshold for this engine and load demand

There are two misfire values shown:

- **Engine Misfire**—The value shown is displayed in percent. The number shown represents the overall percentage of time that the engine is experiencing a cylinder misfire on any cylinder. All marine engines experience cylinder misfire throughout their operating ranges. There is a calibration table in the PCM program that allows for a certain percentage of misfire. The allowable misfire percentages are higher at low RPM and load, and lower at high RPM and load.
- **Cylinder Misfire**—The value shown is displayed in counts. The values are displayed in numerical order for the specific engine that you are viewing. The example shows cylinders 1 through 8. This item provides a more refined view of what's happening in the overall engine misfire scheme, by cylinder.

IMPORTANT: While testing the engine under load, pay attention to the number of misfires per cylinder. If you note that one cylinder or bank of cylinders is misfiring more than the others, it will help you in diagnosing the source of the misfire.

Misfire Troubleshooting

1. Use the CDS G3 tool to ensure that the PCM 09 is using the latest calibration.
2. Because a variety of issues can cause misfires, take care of all other faults first.
IMPORTANT: To ensure that a misfire issue has been resolved, clear the fault in CDS G3 and water test the boat for two run cycles at the same RPM and load at which the last misfire was recorded in CDS G3's freeze frame. It takes two run cycles for a misfire fault to be triggered.
3. Do not assume the issue is resolved until you have tested the boat on the water through two complete OBD-M cycles.
4. If you think that you have found the likely cause of the fault, clear the fault and water test the boat, but take the time to inspect the boat and engine for other areas of concern, such as loose or corroded cables, bent props, hull damage. A few moments spent now may save the need for additional water testing.
5. Pay attention to the freeze frame data. It is a snapshot of the engine at the moment the fault occurred. Does the misfire affect all cylinders and both banks, which might indicate a fault with the fuel or electrical section? Or is it confined to one bank or one cylinder?

Misfires Isolated to One or Two Cylinders

If the misfires are being reported primarily on only one or two cylinders, concentrate on issues that affect individual cylinders:

- Fuel injectors
- Spark plugs and wires
- Coils and distributor cap towers
- Loss of compression

Note that misfires on one cylinder may be reported in data items for nearby cylinders. Check the surrounding cylinders also.

Misfire Isolated to One Bank of Cylinders

If the misfires are affecting one bank of cylinders, first check systems that might affect just that side, such as head gasket integrity.

THE INFORMATION IN THIS DOCUMENT IS CONFIDENTIAL AND PROTECTED BY COPYRIGHT AND IS THE PROPERTY OF MERCURY MARINE.

This document is provided for the sole and exclusive use of the original recipient as prescribed by Mercury Marine and may not be distributed or copied, digitally or otherwise, without the prior written consent of Mercury Marine.

Misfires On All Cylinders

If misfires are occurring across all cylinders, the number of possible causes increases. A systematic approach and further analysis of the freeze frame data is necessary.

1. Do the misfires occur across all power bands, or only under heavy load?
2. Do the misfires seem to happen randomly, perhaps indicating an intermittent problem?
3. Speak to the customer. Were any modifications made to the boat recently? Electronics added? Different fuel used? A different propeller put on? Was the boat run aground, or did it strike an object?
4. Check the fuel pressure with a pressure gauge and use a small tank of known good fuel to eliminate the fuel system as a potential cause. The PCM 09 assumes that the engine is receiving the proper fuel at the proper pressure. There are no CDS G3 faults for bad fuel or low fuel pressure—although these conditions may lead to an I_TERMHIGH fault.

Misfire Troubleshooting Guide

The following steps are intended as a guide. Your experience and situation may suggest alternate avenues.

1. Connect the CDS G3 diagnostic tool to identify the misfire fault.
2. Record the information in the freeze frame buffers to determine the RPM, load, and other conditions at the time the fault was set. When testing to ensure that the problem is resolved, you should try to duplicate these parameters.
3. Interview the customer to determine if the fault occurred after a change in operating habits or loads, boat modifications, or after adding new fuel.
4. Check CDS G3 for any updated reflash packages. Refer to the help screen in CDS G3 for information on reflashing the PCM with the most recent calibration. Check all service bulletins for the engine being worked on.
5. Check for and resolve all other active faults before addressing the misfire fault. Refer to **Service Manual #49, PCM 09 Diagnostics**.
6. Does the engine use a yellow-flag-type 50-amp circuit breaker?
 - If it does, refer to **Misfires Due to Yellow-Flag-Type 50-Amp Circuit Breaker** and follow the steps there. Then proceed to the next step.
 - If it does not, continue to the next step.
7. If the misfire occurs on a 5.0L, 5.7L, or 6.2L EC engine, determine if it meets the following criteria:
 - An engine with relatively low hours—30 to 100.
 - CDS G3 displays an active **396 Engine Misfire Limit Exceeded** fault, and no other active faults. If there are other active faults resolve them first and determine if the misfire fault returns with no other active faults.
 - The misfires are typically apparent when the engine is put under high load, such as when coming on plane and spark advance is at its greatest.

If the engine meets these criteria, refer to **5.0L, 5.7L, and 6.2L ECT Engines Misfire with Low Engine Hours and No Other Active Faults**, and follow the instructions there.

If these conditions don't apply, proceed to the next step.
8. Inspect the engine and drive system for:
 - Fluid leaks, impact damage, incorrect rigging or installation
 - Loose components or brackets, or missing fasteners and cotter pins
 - Evidence of overheating
 - Tampering, incorrect repairs, or modifications, especially to the electrical and fuel systems
 - Low fluid levels and improper serpentine belt tension
 - Improper or damaged propellers

THE INFORMATION IN THIS DOCUMENT IS CONFIDENTIAL AND PROTECTED BY COPYRIGHT AND IS THE PROPERTY OF MERCURY MARINE.

This document is provided for the sole and exclusive use of the original recipient as prescribed by Mercury Marine and may not be distributed or copied, digitally or otherwise, without the prior written consent of Mercury Marine.

9. Inspect the electrical system.
- Look for damaged, melted, or corroded harnesses or cables.
 - Check the spark plug and ignition wires.
 - Check the 90-amp fuse.
 - Verify that the safety lanyard tether is securely connected. Also, inspect for a substandard or defective lanyard switch. These often cause an erratic or intermittent voltage supply to the engine.
 - Verify that the battery is fully charged and is of sufficient capacity for the engine being tested. If in doubt, substitute a battery that is known to be good.
 - Check for loose battery cable connections. Check each end of both cables.
 - A ground stud must first be securely tightened into the engine block and then the nut tightened to the stud. Studs that are loose in the block will cause erratic operation.
 - If the negative battery cable is not connected to the same engine ground stud as the EFI system ground leads, consider moving the negative battery cable to that ground stud.

Repair any issues found.

If you have found a likely cause of the misfire fault, resolved all other faults, updated the PCM with the latest calibrations, and resolved any issues in this step, conduct water testing. Refer to **Water Testing**.

If the misfire fault reoccurs or the likely cause of the fault was not found, continue.

10. Check all manifold vacuum lines for splits, kinks, proper routing, and connections.
- Verify that the fuel pressure regulator vent line is connected to the proper fitting and is not kinked, damaged, or disconnected.
 - A PCV valve acts as a calibrated air leak. If an incorrect or malfunctioning PCV valve is present, engine operation will be most affected at lower engine speeds.
 - Check for air leaks in the induction system caused by loose, leaking, or missing throttle body or intake manifold gaskets.
 - Using the CDS G3 service tool, check the IAC% values at idle and compare them to the values in the appropriate service manual. If they're lower than normal, an air leak in the induction system is likely.

NOTE: *DTS engines do not use an IAC valve. DTS engines will display lower than the normal TPS% specified values when an air leak is present.*

Repair any issues found.

If you have found a likely cause of the misfire fault, resolved all other faults, updated the PCM with the latest calibrations, and resolved any issues in this step, conduct water testing. Refer to **Water Testing**.

If the misfire fault reoccurs or no issue was found, continue.

11. Inspect and test the fuel system:
- Check all fuel line barb fittings closely for any hairline cracks or other damage that may cause an air leak in the fuel delivery system.
 - Test the fuel rail pressure at the engine speed shown in the Freeze Frame Data buffer. Refer to the appropriate service manual for the pressure specification.
 - Fuel pressure must be within 13.7 kPa (2 psi) of the specified fuel rail pressure when the manifold vacuum is nearly the same as the barometric pressure.
 - If the fuel pressure is below specification, refer to **MerCruiser Service Bulletin 99-7** and test the fuel supply system.
 - Run the engine on a portable fuel tank containing fuel that is known to be clean, fresh, and of the proper octane rating. If the problem is resolved, there is a problem within the boat's fuel system or the fuel in its tank.

Repair any issues found.

If you have found a likely cause of the misfire fault, resolved all other faults, updated the PCM with the latest calibrations, and resolved any issues in this step, conduct water testing. Refer to **Water Testing**.

If the misfire fault reoccurs or no issue was found, continue.

12. Check the CDS G3 service tool to see if any Active Tests (Electronic Shift Test, Smart Start Test, or Electronic Throttle Body Test) are available for the engine you are working on.
Perform those tests that are available to verify each system operates correctly.

THE INFORMATION IN THIS DOCUMENT IS CONFIDENTIAL AND PROTECTED BY COPYRIGHT AND IS THE PROPERTY OF MERCURY MARINE.

This document is provided for the sole and exclusive use of the original recipient as prescribed by Mercury Marine and may not be distributed or copied, digitally or otherwise, without the prior written consent of Mercury Marine.

Repair any issues found.

If you have found a likely cause of the misfire fault, resolved all other faults, updated the PCM with the latest calibrations, and resolved any issues in this step, conduct water testing. Refer to **Water Testing**.

If the misfire fault reoccurs or no issue was found, continue.

13. Inspect the ignition system.

- 4.3L, 5.0L, 5.7L, and 6.2L engine models:
 - Verify that the high voltage switch (HVS) is indexed properly with the engine at number 1 cylinder TDC. Refer to the appropriate service manual.
- 4.3L, 5.0L, 5.7L, 6.2L, and 8.2L models:
 - a. Remove the crankshaft position sensor (CPS).
 - b. Inspect the crankshaft reluctor wheel by looking into the bore of the CPS mount. Check for loose fit or cracks in the wheel. Use the starter to bump the engine over until each vane has been inspected.
- 3.0L MPI engine models:
 - Ensure that the crankshaft position sensor air gap is set to 0.64–1.02 mm (0.024–0.040 in.).
 - Inspect the crankshaft reluctor wheel by looking at the outer surface of each vane. Check for excessive paint buildup on the outer surface of each vane. Use the starter to bump the engine over until each vane has been inspected.
- All models: Inspect the spark plug wires.
 - Ensure that the spark plug wires and seals are in good physical shape and not cracked, split, or otherwise damaged.
 - Check for correct routing. Keep the spark plug wires as far away as possible from the engine wiring harness.
- Remove the distributor cap (if equipped) and check for signs of moisture, carbon tracking, and damage.
- Check the distributor cap and rotor, distributor indexing, and coil.
- Remove and inspect the spark plugs:
 - Verify that the correct spark plugs are installed.
 - Replace any spark plug that is damaged, worn, or fouled.
 - Check for indications of mechanical damage, cracked insulators, and incorrect gap.
 - Look for metal transfer, melted electrodes, or blistering on the insulator from preignition or detonation.
 - Checks for signs of spark tracking on the spark plug boot.
 - Check for carbon build-up or fouling from excessive oil consumption or rich air-to-fuel mixtures.
- Use a timing light to look for:
 - Weak or erratic spark
 - Incorrect or erratic ignition timing

Repair any issues found.

If you have found a likely cause of the misfire fault, resolved all other faults, updated the PCM with the latest calibrations, and resolved any issues in this step, conduct water testing. Refer to **Water Testing**.

If the misfire fault reoccurs or no issue was found, continue.

14. Inspect the PCM connectors.

- Verify that all of the connectors are securely attached and locked (if equipped with locks).
- Unplug and inspect the three PCM connectors.
 - a. Ensure that none of the PCM pins are bent or otherwise damaged.
 - b. Inspect for terminal corrosion, terminal or body damage, and indications of abuse to the pin locking mechanisms.
 - c. Check for melted, chafed, or other insulation damage. Inspect for evidence of short circuits or other damage that will prevent proper function.

Repair any issues found.

If you have found a likely cause of the misfire fault, resolved all other faults, updated the PCM with the latest calibrations, and resolved any issues in this step, conduct water testing. Refer to **Water Testing**.

If the misfire fault reoccurs or no issue was found, continue.

THE INFORMATION IN THIS DOCUMENT IS CONFIDENTIAL AND PROTECTED BY COPYRIGHT AND IS THE PROPERTY OF MERCURY MARINE.

This document is provided for the sole and exclusive use of the original recipient as prescribed by Mercury Marine and may not be distributed or copied, digitally or otherwise, without the prior written consent of Mercury Marine.

15. Unplug and inspect the EFI sensors and actuators.
- Inspect for terminal corrosion, terminal or body damage, and indications of abuse to the pin locking mechanisms.
 - Check for signs of tampering, corrosion, damage to the pin locking mechanisms, melted insulation, and other evidence of short circuits or damage that would prevent proper function.
 - Based on the results of the inspection, further inspection of the harness may be necessary, including wire and connector wiggle tests.

NOTE: *If there is damage to the external connections, inspect the related internal wire splices for damage.*

Repair any issues found.

If you have found a likely cause of the misfire fault, resolved all other faults, updated the PCM with the latest calibrations, and resolved any issues in this step, conduct water testing. Refer to **Water Testing**.

If the misfire fault reoccurs or no issue was found, continue.

16. Check the boat wiring harness and engine wiring harness.
- On mechanical shift engines:
 - a. Isolate the boat harness from the engine using the 14-pin shunt tool or a key switch harness that uses the 14-pin connector.
 - b. Clear the OBD-M faults using the CDS G3 tool and test run the boat on open water.
 - c. If the fault does not return, a problem exists in the boat harness or helm harness.
 - On DTS engines:
 - a. If available, substitute the boat's helm and 14-pin main harness with a test helm and harness.
 - b. Clear the OBD-M faults using the CDS G3 tool and test run the boat on open water.
 - c. If the fault does not return, a problem exists in the boat harness or helm harness.

Repair any issues found.

If you have found a likely cause of the misfire fault, resolved all other faults, updated the PCM with the latest calibrations, and resolved any issues in this step, conduct water testing. Refer to **Water Testing**.

If the misfire fault reoccurs or no issue was found, continue.

17. Check the engine for
- Sticking intake or exhaust valves
 - Mechanical problems related to valve operation
 - Combustion chamber leakage caused by damaged cylinders, pistons, rings, head gaskets, and valves
 - Internal engine noise, knocking, etc.
 - Correct compression
 - a. Refer to the appropriate service manual and perform a compression test at engine cranking speed. Compare the readings to specifications.
 - b. If compression test results are not within specification, perform a cylinder leak-down test to isolate the problem.

Repair any issues found.

If you have found a likely cause of the misfire fault, resolved all other faults, updated the PCM with the latest calibrations, and resolved any issues in this step, conduct water testing. Refer to **Water Testing**.

If the misfire fault reoccurs, contact Mercury Product Support.

Water Testing

Two engine run cycles are required to set an OBD-M fault. The fault must be present during both run cycles. Therefore, after the cause of the misfire has been corrected, or if you suspect you have corrected the problem, you must verify that the fault has been resolved by observing two complete diagnostic cycles of the OBD-M catalyst monitor diagnostic routine self-test. The catalyst monitor tests must complete for the cycle to be complete.

- The first time an OBD-M fault occurs, the PCM will internally record this event, but there will be no indication to the operator or technician that this has occurred.
- If the same fault occurs during any subsequent engine run cycle, the fault will activate and be visible on the CDS G3 service tool and SmartCraft displays, and the OBD-M indicator light will illuminate.

THE INFORMATION IN THIS DOCUMENT IS CONFIDENTIAL AND PROTECTED BY COPYRIGHT AND IS THE PROPERTY OF MERCURY MARINE.

This document is provided for the sole and exclusive use of the original recipient as prescribed by Mercury Marine and may not be distributed or copied, digitally or otherwise, without the prior written consent of Mercury Marine.

Therefore, if the boat can be run at the same load and conditions as recorded in the Freeze Frame at the time of the previous misfire fault and the catalyst monitor diagnostic routine self-test can complete twice without faults displayed on the CDS G3 service tool, the fault can be considered resolved and the boat returned to the customer.

NOTE: The catalyst monitor diagnostic routine can be monitored with the CDS G3 service tool, software version 1.3 or higher.

NOTE: Certain active faults will prevent the OBD-M self-diagnostic routines from initiating. They are active faults related to the following systems: ECT, EMCT, IAT, fuel injectors, oxygen sensors, TPS, and voltage. Correct all active faults before attempting to verify the OBD-M self-diagnostic routines. If the Guardian protection system is active, the OBD-M self-diagnostic routines will not initiate.

The OBD-M self-diagnostic routine can be observed on the datastream of the CDS G3 service tool. Software version 1.3 or higher must be used for the following procedure.

Water Test Procedure

IMPORTANT: Do not perform this procedure using a flushing attachment or in a test tank.

After the cause of the cylinder misfire has been corrected, proceed as follows:

- Having recorded the Freeze Frame data (refer to **Misfire Troubleshooting Guide**) at the time of the previous misfire fault, erase all faults (active and freeze frame) using the CDS G3 service tool.

IMPORTANT: It is important to duplicate the conditions recorded at the time of misfire fault to ensure that the cause of the misfire has been resolved. Review the misfire counts in G3 to make sure that excessive misfires are not being recorded, especially under the previous conditions.

- Being certain to recreate the misfire conditions recorded in the Freeze Frame at the time of the previous fault for 3–5 minutes, operate the boat in an open body of water until the OBD-M catalyst monitor diagnostic routine self-test has completed. Review the misfire counts in G3 to make sure that excessive misfires are not being recorded, especially under the previous conditions. The test is complete when the data items "Port Catalyst Monitor Raw OSC" and "STBD Catalyst Monitor Raw OSC" display numeric values and "FinishedKey" appears in the pre O2 sensor monitor as well as the port and starboard catalyst monitor data fields. Refer to **Test Completion**.

Knock Retard	0.0,0.0,0.0,0.0,0.0,0.0,0.0,0.0								KnkSpkAdv
	Cyl1	Cyl2	Cyl3	Cyl4	Cyl5	Cyl6	Cyl7	Cyl8	
KnkSpkAdv	0.0	0.0	0.0	0.0	0.0	0.0	0.0	0.0	
Engine Misfire	12.50								Engine_PercentMisfire
Cylinder Misfire (in firing order)	0,0,0,0,2906,934,0,0								CylMisfire_CountArr
	0	0	0	0	2	9	0	0	

Knock Retard	0.0,0.0,0.0,0.0,0.0,0.0,0.0,0.0								KnkSpkAdv
	Cyl1	Cyl2	Cyl3	Cyl4	Cyl5	Cyl6	Cyl7	Cyl8	
KnkSpkAdv	0.0	0.0	0.0	0.0	0.0	0.0	0.0	0.0	
Engine Misfire	01.50								Engine_PercentMisfire
Cylinder Misfire (in firing order)	0,3,0,0,3,0,0,0								CylMisfire_CountArr
	0	3	0	0	3	0	0	0	

54766

- a - Engine misfire percentage before
- b - Cylinder misfire before
- c - Engine misfire percentage after
- d - Cylinder misfire after

- Turn the ignition switch to the off position.
- On DTS models move the remote control handle to the reverse gear, wide-open throttle position. This will disable the trim with key-off feature and shut down the PCM.

THE INFORMATION IN THIS DOCUMENT IS CONFIDENTIAL AND PROTECTED BY COPYRIGHT AND IS THE PROPERTY OF MERCURY MARINE.

This document is provided for the sole and exclusive use of the original recipient as prescribed by Mercury Marine and may not be distributed or copied, digitally or otherwise, without the prior written consent of Mercury Marine.

5. Repeat steps 2–3. The OBD-M self-diagnostic routine must be completed twice in order to ensure that no OBD-M faults return.
6. Review the data in the CDS G3 Live Data Display obtained from the OBD-M Catalyst Monitor diagnostic routine. The four major data items that must be evaluated at the end of the self-diagnostics are:
 - PORT Catalyst Monitor Ratio
 - PORT Catalyst Monitor Raw OSC (OSC—Oxygen Storage Capacity)
 - STBD Catalyst Monitor Ratio
 - STBD Catalyst Monitor Raw OSC

NOTE: These data items are shown in the following screen image as an example from an 8.2L engine.

STBD Engine - City ID: 11			
Description	Values	Name	Units
PORT Catalyst Monitor Ratio	4.07	CATM_r_OSCIndexE WMAPort	Ratio
PORT Catalyst Monitor Raw OSC	1110.67	CATM_t_OSCRawPort	mg
STBD Catalyst Monitor Ratio	2.22	CATM_r_OSCIndexE WMAStbd	Ratio
STBD Catalyst Monitor Raw OSC	417.44	CATM_t_OSCRawStbd	mg

49250

Four major data items to review

7. Interpret the Catalyst Monitor Raw OSC and Catalyst Monitor Ratio data from the CDS G3 service tool.
 - Typical minimum values for oxygen storage capacity per engine model are:

Lowest Acceptable Raw OSC	
3.0L	150 minimum Raw OSC
4.3L	100 minimum Raw OSC
5.0–6.2L	200 minimum Raw OSC
8.2L	330 minimum Raw OSC

- The minimum catalyst monitor ratio is 1.0 or higher for all displacements.
8. Evaluate the Catalyst Monitor Raw OSC and the Catalyst Monitor Ratio data shown in the CDS G3 screen images. Refer to **Test Completion** for an example.

THE INFORMATION IN THIS DOCUMENT IS CONFIDENTIAL AND PROTECTED BY COPYRIGHT AND IS THE PROPERTY OF MERCURY MARINE.

This document is provided for the sole and exclusive use of the original recipient as prescribed by Mercury Marine and may not be distributed or copied, digitally or otherwise, without the prior written consent of Mercury Marine.

Test Completion

When all of the OBD-M monitors have completed their diagnostic testing, the Live Data screen will display **Finished** and **FinishedKey** messages in the appropriate rows, as shown following.

Name	Value	Units	Description
O2Adpt_ITerm_PortTbl	-0.04,0.00,0.00,0.00,0.00,0.00		PORT Short Term Adaption T
PO2S_e_DisableReason	Finished		Post O2 Sensor Monitor
O2SR_e_SwitchRatioDisableReason	FinishedKey		Pre O2 Sensor Monitor
O2SR_e_DisableReasonPort	None		PORT Pre O2 Sensor Monitor
O2SR_e_DisableReasonStbd	None		STBD Pre O2 Sensor Monitor
O2SR_PreCatSwitchPort	0.88	Ratio	PORT Pre O2 Sensor (A) Mon Ratio
O2SR_PreCatSwitchStbd	0.80	Ratio	STBD Pre O2 Sensor (A) Mon Ratio
CATM_e_DisableReasonCommon	None		OVERALL Catalyst Monitor
CATM_e_StatusPort	FinishedKey		PORT Catalyst Monitor
CATM_e_StatusStbd	FinishedKey		STBD Catalyst Monitor
CATM_O2LeanRespTimePort	0.40	ms	PORT Pre O2 Sensor (A) Lear Response
CATM_O2RichRespTimePort	0.11	ms	PORT Pre O2 Sensor (A) Rich Response
CATM_O2LeanRespTimeStbd	0.25	ms	STBD Pre O2 Sensor (B) Lear Response
CATM_O2RichRespTimeStbd	0.10	ms	STBD Pre O2 Sensor (B) Rich Response
CATM_r_OSCIndexEWMAPort	0.87	Ratio	PORT Catalyst Monitor Ratio
CATM_t_OSCRawPort	210.45	mg	PORT Catalyst Monitor Raw O
CATM_r_OSCIndexEWMAStbd	0.73	Ratio	STBD Catalyst Monitor Ratio
CATM_t_OSCRawStbd	175.26	mg	STBD Catalyst Monitor Raw C

54085

Example of Live Data screen at completion of tests. Actual values may differ. Note that the catalyst monitor ratios indicate that both catalysts are damaged.

- a** - Pre O2 sensor monitor—FinishedKey
- b** - Port and starboard catalyst monitors—FinishedKey
- c** - Catalyst response times (all less than 0.92 seconds)
- d** - Port catalyst monitor ratio—failed (value is less than 1)
- e** - Starboard catalyst monitor ratio—failed (value is less than 1)

In the example above, **FinishedKey** is shown in the status of the port and starboard catalyst monitors, the last monitors to run. When these values are displayed, it indicates the completion of one OBD-M self-diagnostic routine.

Note that the catalyst monitor ratios for both the port and starboard catalysts are less than one and the response times are less than 0.92 seconds, indicating that the catalysts have been damaged and need replacement.

After completing the OBD-M self-diagnostic routine twice with no faults indicated on the CDS G3 service tool, the boat can be returned to the customer.

THE INFORMATION IN THIS DOCUMENT IS CONFIDENTIAL AND PROTECTED BY COPYRIGHT AND IS THE PROPERTY OF MERCURY MARINE.

This document is provided for the sole and exclusive use of the original recipient as prescribed by Mercury Marine and may not be distributed or copied, digitally or otherwise, without the prior written consent of Mercury Marine.

Special Misfire Cases

Misfires Due to Yellow-Flag-Type 50-Amp Circuit Breaker

Since 2002, some engines were manufactured with a yellow-flag-type circuit breaker. The 50-amp circuit breaker is the main voltage supply (through the main power relay) for the engine fuse block, which supplies voltage to the fuel injectors, coil and coil driver, PCM drivers, all 5-volt and 12-volt sensors, and O2 sensor heaters.

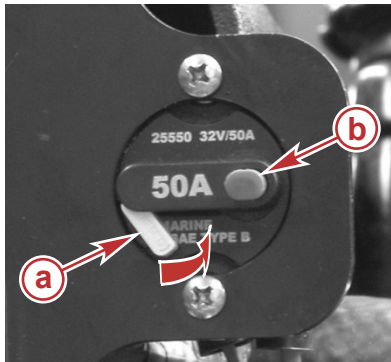

54122

Yellow flag type 50-amp circuit breaker

- a - Yellow flag
- b - Red test button

The yellow-flag-type circuit breaker has been associated with misfires between 2000 and 4000 RPM. This RPM range is where the engine is at its peak load, as when working to get the boat up on plane. This is when the ignition system has the most demand for energy to fire the spark plug and also when it needs the most spark timing advance and injector-on time.

Excessive engine vibration and boat harmonics at some RPM ranges may contribute to a momentary loss of voltage with engines using the yellow-flag-type 50-amp circuit breaker.

If temporarily bypassing the circuit breaker resolves the fault, replace the circuit breaker with a push-button type.

To Temporarily Bypass the Circuit Breaker

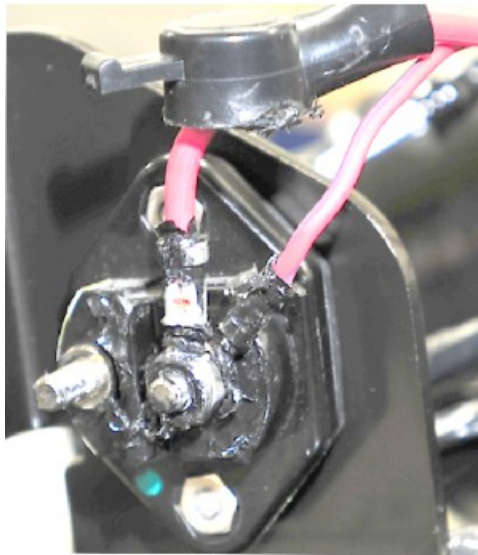

53947

To test, temporarily bypass the circuit breaker. Replace it or return it to its original configuration before returning the boat to the customer.

1. Disconnect the positive battery cable before proceeding.
IMPORTANT: Bypassing the circuit breaker is for temporary testing purposes only. The circuit breaker must be replaced or returned to its original configuration before the boat is returned to the customer.
2. Remove either the red or red/purple wires from one of the terminal studs on the back of the 50-amp circuit breaker.
3. Temporarily connect the red and red/purple wire eyelets together on one of the electrical terminal studs.

THE INFORMATION IN THIS DOCUMENT IS CONFIDENTIAL AND PROTECTED BY COPYRIGHT AND IS THE PROPERTY OF MERCURY MARINE.

This document is provided for the sole and exclusive use of the original recipient as prescribed by Mercury Marine and may not be distributed or copied, digitally or otherwise, without the prior written consent of Mercury Marine.

4. Before you reconnect the positive battery cable, make certain to use one of the boot protectors over the terminal stud to prevent the wires from coming into contact with any engine ground.
5. Reconnect the positive battery cable, and water test the boat.
6. If bypassing the circuit breaker resolves the issue, replace it with the newer type.

NOTE: The flag-type circuit breakers have been superseded by the push-button type.

IMPORTANT: Do not return the boat to the customer with the circuit breaker bypassed.



New type 50-amp circuit breaker

7. If bypassing the circuit breaker does not resolve the issue, disconnect the battery, and return the circuit breaker wiring to its original configuration. Do not return the boat to the customer with the circuit breaker bypassed.

Additionally, make sure that the 90-amp fuse block at the starter solenoid is secured properly, as this also could have an adverse effect on voltage.

5.0L, 5.7L, and 6.2L ECT Engines Misfire with Low Engine Hours and No Other Active Faults

There have been instances of misfiring occurring on 5.0L, 5.7L, and 6.2L ECT engines with relatively low hours and in a certain power range. The remedy for this particular misfire cause is unique to this issue, so ensure that the situation meets the following criteria:

- An engine with relatively low hours—30 to 100.
- CDS G3 displays an active 396 Engine Misfire Limit Exceeded fault.
- No other active faults are displayed.
- The misfires are typically apparent when the engine is put under high load, such as when coming on plane, and spark advance is at its greatest.

THE INFORMATION IN THIS DOCUMENT IS CONFIDENTIAL AND PROTECTED BY COPYRIGHT AND IS THE PROPERTY OF MERCURY MARINE.

This document is provided for the sole and exclusive use of the original recipient as prescribed by Mercury Marine and may not be distributed or copied, digitally or otherwise, without the prior written consent of Mercury Marine.

Causes

After 30–100 engine hours, the tolerance between the distributor (high-voltage switch) and the drive components may increase. As the timing chain, timing gears, distributor shaft drive gear and cam gear all wear in, the rotor shaft may become slightly out of phase with the distributor housing, which can result in misfire under load.

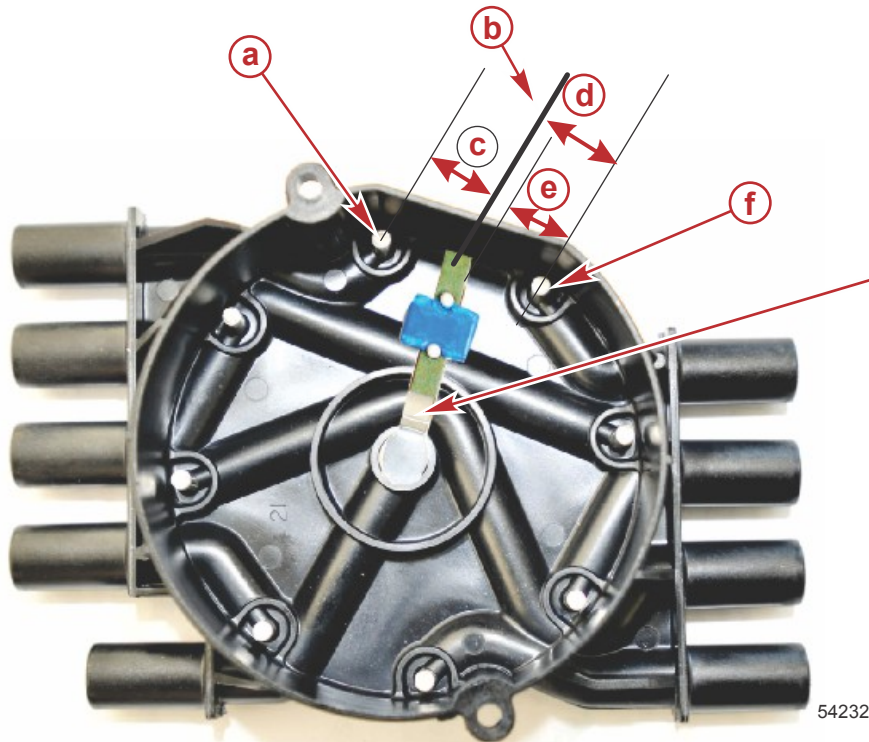

Distributor/HVS rotor positions before adjustment

- a** - Tower for cylinder just fired
- b** - Midpoint between two cylinder towers. Also the position of the rotor at maximum spark advance.
- c** - Space between rotor and cylinder just fired at maximum spark advance
- d** - Space between rotor and cylinder fired at 30° before TDC (maximum spark advance)
- e** - Approximately 24° before TDC
- f** - Tower of cylinder to be fired
- g** - Rotor

MerCruiser ignition systems are capable of producing 50,000-volt sparks. Voltage, similar to pressure in a hydraulic system, is the force necessary to jump the gap between the tower and rotor. In the case of distributors, it is measured in thousands of volts, or kV (kilovolts); 1000 volts=1 kV. The spark will be attracted to the nearest conductor, or the path of least resistance.

Under heavy load, such as when bringing the boat on plane or pulling a skier, spark advance, injector on time, and spark energy demand are at their greatest. If the distributor/HVS is incorrectly positioned, the spark may fire when the rotor is midway between the desired distributor tower and the one preceding it. This provides multiple paths for the high voltage spark, and is like trying to fire two cylinders at once. A lower voltage (less than the required KV) is then delivered to the correct distributor tower. This results in less voltage being sent to the spark plugs, causing a weaker spark, and is one possible cause of cylinder misfires.

Solution

Since this solution is only required in these certain cases, it is important to follow the misfire diagnostic procedure listed previously. This issue is usually unaccompanied by other faults, and the misfires typically occur only in the power range where spark advance is at its greatest, and at a time when the engine has gone through its initial break-in process.

NOTE: This procedure requires a position indicator light, which can be constructed from the parts listed. This tool will provide a visual indication when the distributor is properly positioned.

THE INFORMATION IN THIS DOCUMENT IS CONFIDENTIAL AND PROTECTED BY COPYRIGHT AND IS THE PROPERTY OF MERCURY MARINE.

This document is provided for the sole and exclusive use of the original recipient as prescribed by Mercury Marine and may not be distributed or copied, digitally or otherwise, without the prior written consent of Mercury Marine.

Construct a Position Indicator Light

The position indicator light will plug into the camshaft position sensor connector on the distributor/HVS and provide a visual indication when the distributor is properly positioned.

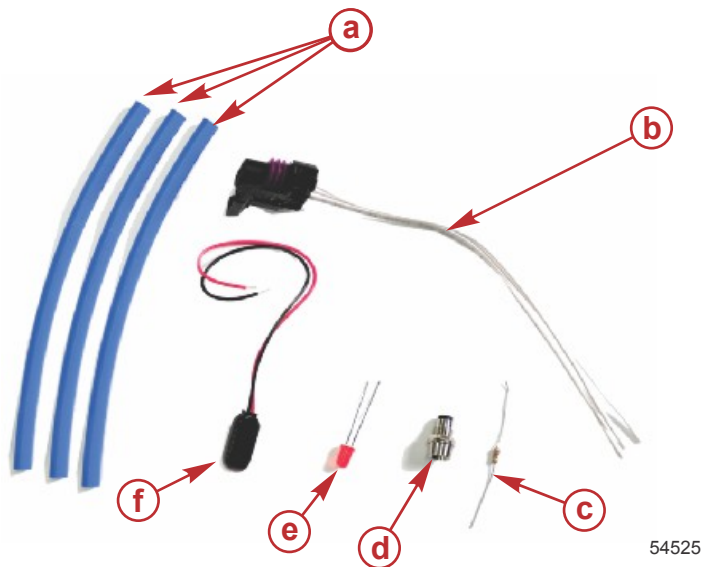

Position indicator light components

- a- Heat shrink tubing (obtain locally) (three 3 in. lengths)
- b- Camshaft position sensor connector (from P/N 879346A34)
- c- 470 ohm ¼ watt resistor (obtain locally)
- d- LED holder (obtain locally)
- e- 5mm LED (obtain locally)
- f- 9-volt battery connector (obtain locally)

Also required: 9-volt battery (obtain locally)

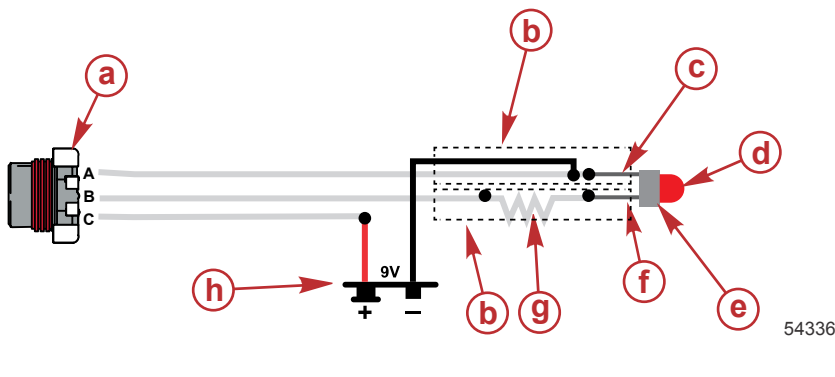

Position indicator light schematic

- a- Camshaft position sensor connector (from P/N 879346A34)
- b- Heat shrink tubing
- c- Cathode (-) (short lead) of light emitting diode (LED)
- d- LED
- e- LED holder
- f- Anode (+) (long lead) of LED
- g- 470 ohm ¼ watt resistor
- h- 9-volt battery connector

Constructing the Position Indicator Light

IMPORTANT: Crimping, not soldering, the connections is recommended to ensure solid connections and to reduce the possibility of damaging the LED.

1. Identify the A, B, and C connectors on the camshaft position sensor connector.
2. Place heat shrink over each of the three wires coming from the camshaft position sensor connector.
3. Trim the leads on the 470 ohm resistor and connect one end to the anode (+) (the longer lead) of the LED.
4. Connect the wire from the camshaft position sensor connector B to the free end of the resistor.
5. Cover the resistor, including the crimps, and the anode with one heat shrink.
6. Connect the wire from the camshaft position sensor connector A and the black (negative) lead from the 9-volt battery connector to the cathode of the LED, and cover the connection and cathode with heat shrink.
7. Connect the red (positive) wire from the battery connector to the wire coming from connector C of the camshaft position sensor connector, and cover the connection with heat shrink.
8. To test the indicator light,
 - a. Connect a known good 9-volt battery to the battery connector.
 - b. Place a jumper across terminals B and C of the camshaft connector. The LED should illuminate. If it does not, verify that the connections are secure.

THE INFORMATION IN THIS DOCUMENT IS CONFIDENTIAL AND PROTECTED BY COPYRIGHT AND IS THE PROPERTY OF MERCURY MARINE.

This document is provided for the sole and exclusive use of the original recipient as prescribed by Mercury Marine and may not be distributed or copied, digitally or otherwise, without the prior written consent of Mercury Marine.

- When the position indicator light works, apply heat to the heat shrink tubing.

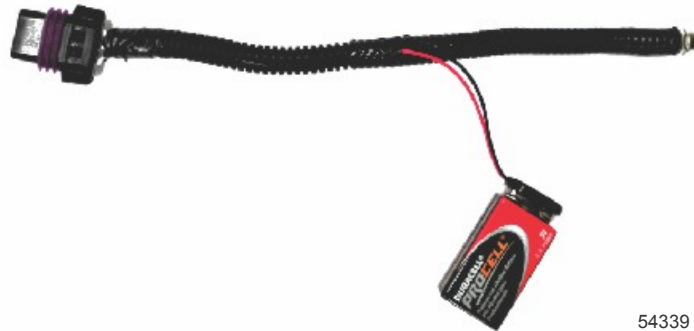

54339

Finished position indicator light shown with optional conduit covering

Positioning the Distributor/HVS

⚠ WARNING

Avoid serious injury from accidental engine start up. Disable the ignition system before turning the engine over. Turn the key to the off position, remove the key from the key switch, and turn the lanyard safety switch to the off position before activating a remote starter switch.

- Disable the ignition system by turning the key to the off position, removing the key from the switch, and turning the lanyard safety switch to the off position.
- Locate a timing mark 1-1/16 in. from 0° using a decal (Mercury part number 8M0079626) or the included template.
 - Due to the possibility that this document was scaled up or down by your printer, confirm that the highlighted mark on the timing decal (refer to **Timing Decal**) is 1-1/16 in. to the right of the 0° mark.

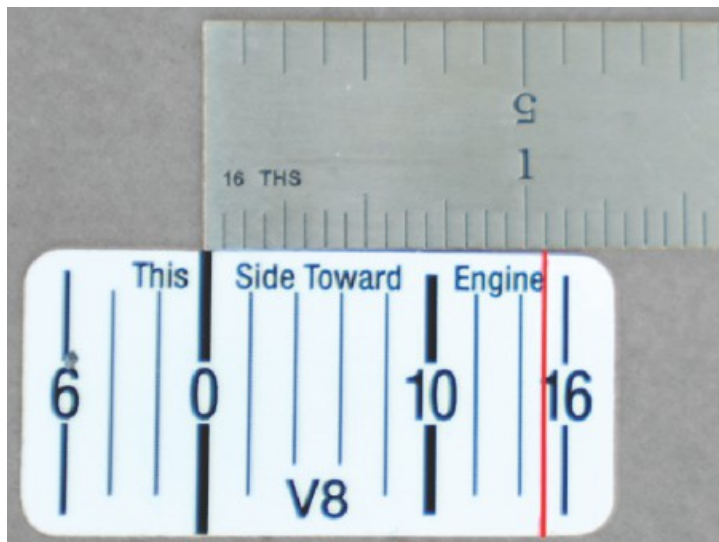

54504

Add a mark 1-1/16 in. to the right of the 0° mark (not shown to scale)

- Alternately, order timing decal kit 8M0079626, and place an easily identifiable mark 1-1/16 in. to the right of the 0° mark.
- Using a remote starter switch, crank the engine until the timing mark on the harmonic balancer is visible.

THE INFORMATION IN THIS DOCUMENT IS CONFIDENTIAL AND PROTECTED BY COPYRIGHT AND IS THE PROPERTY OF MERCURY MARINE.

This document is provided for the sole and exclusive use of the original recipient as prescribed by Mercury Marine and may not be distributed or copied, digitally or otherwise, without the prior written consent of Mercury Marine.

4. Highlight the index mark and 0° mark on the harmonic balancer to make lining up the decal easier.



54505

5. Attach the timing template or decal to the harmonic balancer, ensuring that the 0° marks on both the balancer and decal align.

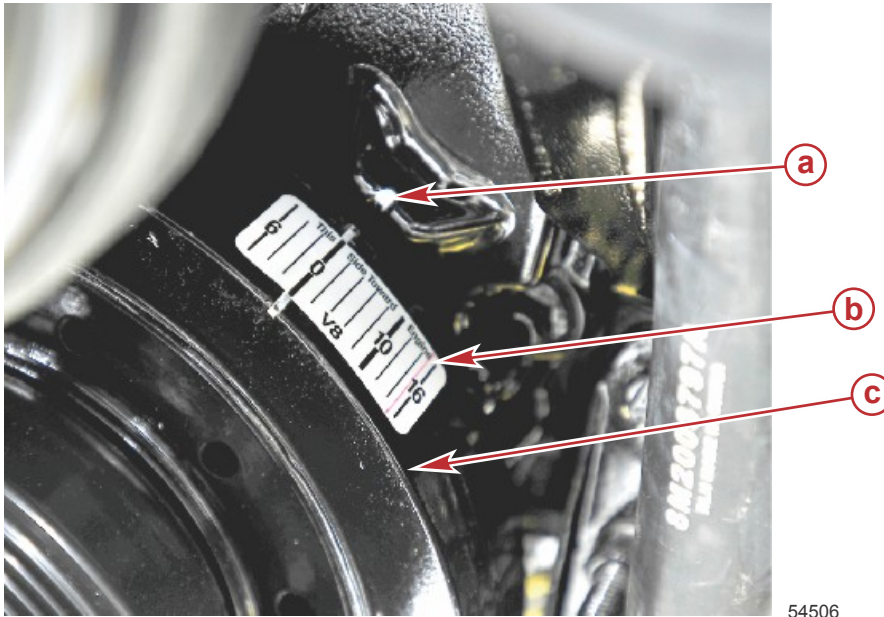

- a - Index mark
- b - Timing template with 1-1/16 in. mark highlighted
- c - Harmonic balancer

54506

6. To ensure that the cylinder #1 is on the compression stroke:
 - a. Remove the distributor cap and note the position of the rotor.

NOTE: *The harmonic balancer will rotate twice for each revolution of the rotor.*

IMPORTANT: Do not turn the engine in reverse (counterclockwise) to align the marks. Doing so will void the procedure.

THE INFORMATION IN THIS DOCUMENT IS CONFIDENTIAL AND PROTECTED BY COPYRIGHT AND IS THE PROPERTY OF MERCURY MARINE.

This document is provided for the sole and exclusive use of the original recipient as prescribed by Mercury Marine and may not be distributed or copied, digitally or otherwise, without the prior written consent of Mercury Marine.

- b. Using a remote starter switch, crank the engine until the index mark on the harmonic balancer is at the 15° mark and the rotor is near the "8" marking on the distributor housing. It may be necessary to use a remote switch to get close to the position, and then use a breaker bar and socket to precisely align the marks. If you overshoot the mark, crank the engine through two revolutions until the rotor is near the "8" marking. Do not back up.

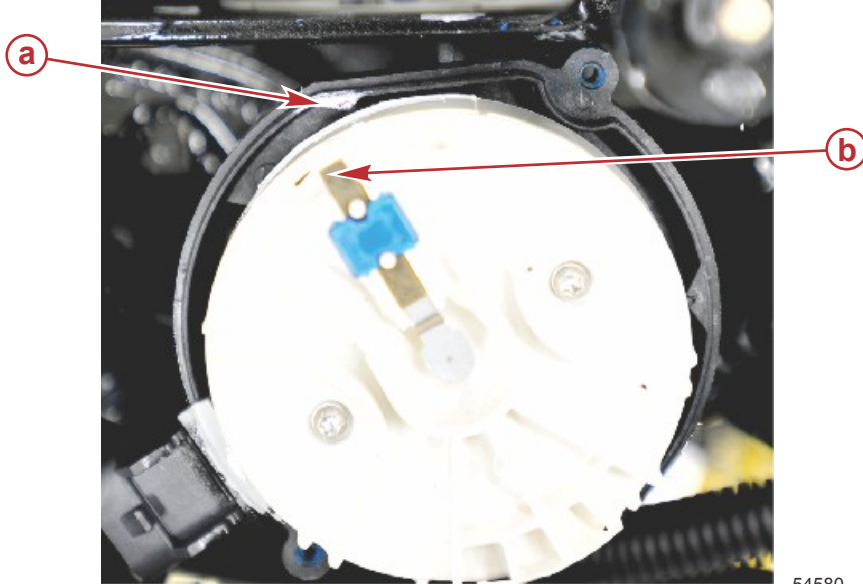

- a - "8" marking on distributor housing
- b - Rotor

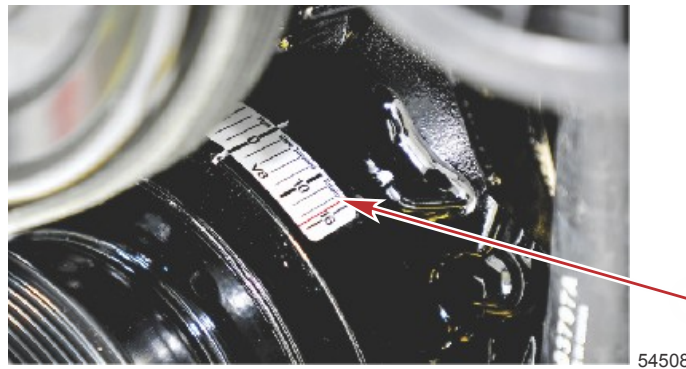

Crankshaft rotated until number 1 cylinder is 15° before top dead center (BTDC)

7. Install the distributor cap.
8. Mark the position of the distributor/HVS switch to ensure that it can be restored to its initial position, if necessary.
9. Disconnect the camshaft sensor connector from the distributor/HVS and plug the position indicator light in its place.

THE INFORMATION IN THIS DOCUMENT IS CONFIDENTIAL AND PROTECTED BY COPYRIGHT AND IS THE PROPERTY OF MERCURY MARINE.

This document is provided for the sole and exclusive use of the original recipient as prescribed by Mercury Marine and may not be distributed or copied, digitally or otherwise, without the prior written consent of Mercury Marine.

10. Loosen the distributor/HVS lockdown screw only enough so that the distributor HVS can be rotated with some effort. It should not rotate freely.

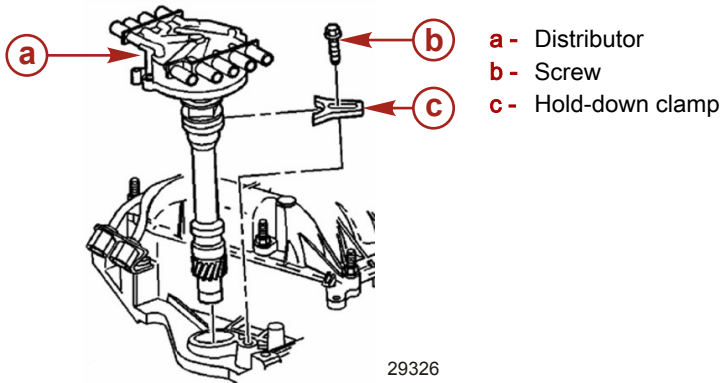

11. Rotate the distributor/HVS clockwise until the light comes on; then, rotate it slowly counterclockwise until the light goes out.

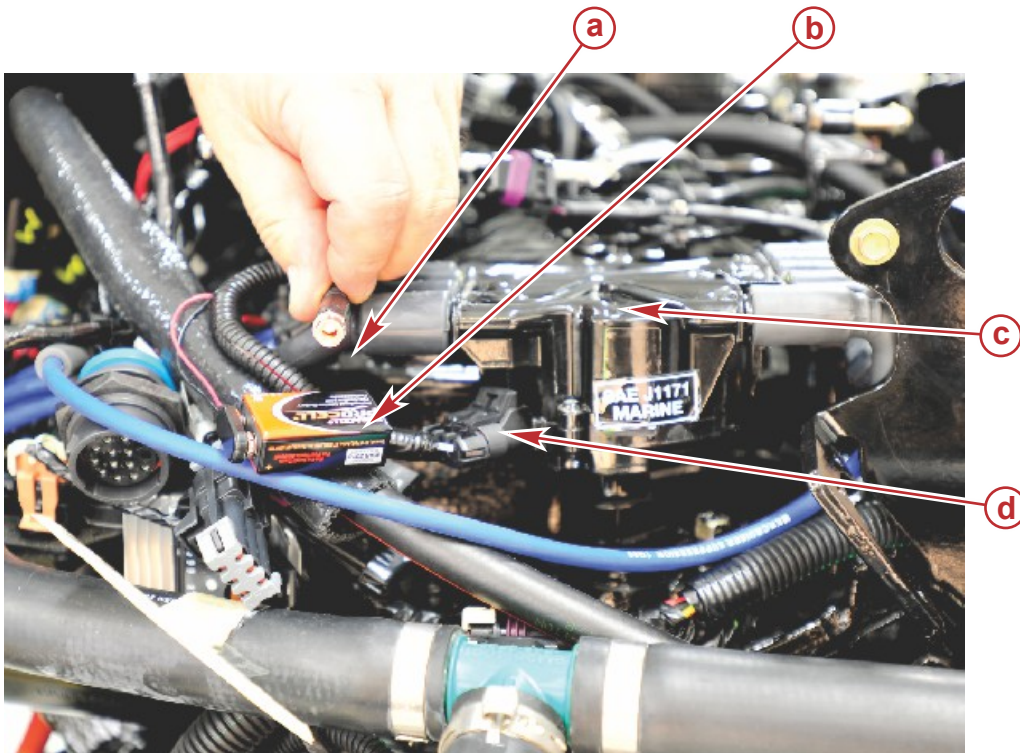

54345

- a** - LED
b - 9-volt battery
c - Distributor/HVS cap
d - Position indicator light plugged into the camshaft sensor connector

12. As soon as the light is out, tighten the distributor/HVS lockdown screw to the specified torque.

Description	Nm	lb-in.	lb-ft
Distributor/HVS lockdown screw	25	-	18.4

THE INFORMATION IN THIS DOCUMENT IS CONFIDENTIAL AND PROTECTED BY COPYRIGHT AND IS THE PROPERTY OF MERCURY MARINE.

This document is provided for the sole and exclusive use of the original recipient as prescribed by Mercury Marine and may not be distributed or copied, digitally or otherwise, without the prior written consent of Mercury Marine.

13. Enable the ignition system and water test the boat. Refer to **Water Testing**. Keep the CDS G3 connected to the engine and have an assistant watch the misfire monitor counts on the live data stream as the boat is brought up on plane, to confirm that the issue has been resolved. If the engine is still recording excessive misfires, continue with misfire troubleshooting.

Timing Decal

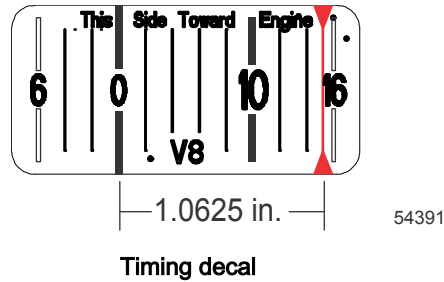

Verify that the distance indicated is actually 1-1/16 in. before attaching the decal or cutout to the harmonic balancer.

THE INFORMATION IN THIS DOCUMENT IS CONFIDENTIAL AND PROTECTED BY COPYRIGHT AND IS THE PROPERTY OF MERCURY MARINE.

This document is provided for the sole and exclusive use of the original recipient as prescribed by Mercury Marine and may not be distributed or copied, digitally or otherwise, without the prior written consent of Mercury Marine.